

# FC114ASP

Creasing, Numbering,  
Strike & Rotary Perf/Scoring



Serial Number \_\_\_\_\_

Date \_\_\_\_\_

# Table of Contents

<b>Product Information</b>	<b>Page</b>
Specifications	1a
Safety Procedures/Care & Maintenance	1b
Component Identification	2
Setting Up Your FC114ASP	3
Touch Screen Control	4
Perforation Mode	5
Feeder Mode	6
Crease Mode	6
Number Mode	7
Programming for Number Mode	7
Transport Operation	8
Programming for Crease Mode	8
Half Fold	8
Tri-Fold	9
Z-Fold	9
Letter Fold	9
Roll Fold	9
Gate Fold	10
Double-Gate Fold	10
Double-Parallel Fold	10
Perfect Bind Double Hinge	10
Perfect Bind Single Hinge	11
Perfect Bind No Hinge	11
Custom Crease Setups	11
Saving/Recalling Custom Jobs	12
Micro Adjusting the Crease Position	12
Batch Counter	13
Tool Holder Assembly	14
Feed Table Assembly	15
Delivery Tray Assembly	15
Adjusting Feed Rails	16
Loading the Feeder	17
Setting the Automatic Feeder	17
Feeding Notes	18
Numbering Head	19
Head Parts	20
Depressing a Wheel	21
Changing the Direction of the Head	21
Adjusting the Vertical Bracket	22
Adjusting for a Level Impression	22
Tips for Leveling the Head	23
Setting the Repeat Selector	23
Ink Cartridge	24
Rotary Perforator and Score Assembly	25
Perforation and Scoring Assemblies	25
Gripper Wheel Perforation, Score Mounting	25
Folding Direction of Paper	25
Adjusting RAC rollers (depth of crease)	26
Adjusting RAC Top Dead Center	26
Changing Lower Crease Die	26
Checking the Sensors	27
Drive Train Tension	27
Removing the Perforation Shaft to Change Configurations	28
Troubleshooting	29
Strike Perf Assembly Setup and Use	31

# ELECTRICAL REQUIREMENTS AND SPECIFICATIONS

Power Requirement: 110 or 220V, 50-60 HZ, AC,  
Circuit Protection: 20 AMP Circuit Breaker

NOTE: Older buildings, overloaded lines, and bad grounds can affect the operation of your FC114ASP. A dedicated line is best.

## OPERATING SPEEDS

MODE	TRANSPORT SPEED (Feet per Sec.)	8.5x11 Sheet(est)	5 1/2" Sheet(est)
Perf Mode	2.5	12000	14000
Number Mode	2.0	6000	8000
Crease Mode	2.0	4500	5500

## SPECIFICATIONS

Net weight: FC114ASP	350lbs.
Overall Dimensions:	42" L x 30" W x 42" D Min.
Min. Sheet Size:	5" x 5-7/8"
Max. Sheet Size:	18" W x 20" L x 24" L*
dB (Loudness) Rating	89dB

**\*NOTE:** The FC114ASP is capable of handling many types of applications above and beyond the standard specifications. It is possible to feed quite a variety of jobs, from 30" sheets to die cut stocks. However, the performance of the FC114ASP on these special applications is directly related to the experience of the operator.

# SAFETY PROCEDURES

## BEFORE USE:

- Read through the owner's manual. Follow instructions CAREFULLY.
- NEVER use a wet area. Electric shock could occur.
- Use a GROUNDED outlet and a GROUNDED circuit. Do not use ungrounded equipment on the same circuit.
- Always use a dedicated line. DO NOT use with line splitting surge protector.

## DURING USE:

- Keep fingers and hands away from creasing bar, perf blades, and rubber rollers.
- Keep cords clear of moving parts.

## AFTER USE:

- Turn off machine at the power switch, then unplug the main power cord. This will prevent damage to your machine by power/voltage spikes.
- To unplug cords, always grasp the plug body, never pull on cords to disconnect. Wire fatigue and possible shock could result from improper disconnect procedures.

## BE ALERT! BE CAREFUL!

# CARE AND MAINTENANCE

The FC114ASP is a precision machine. It is very important to keep it free of excessive dust, dirt and foreign matter. We recommend that you keep the machine **covered** when not in use.

**BEARINGS:** The FC114ASP uses 2 different style bearings sealed roller bearing and bronze bushings. Sealed roller bearings are designed to be self-lubricating, however dirt and dust can get into them causing clogging and dirt build up. Bronze bushings need to be oiled on a regular basis. The bronze bushings on this machine are located on the operator side frame and have the perf shaft and exit shaft through them. There are also 2 bushings located on the feed drive shaft. To oil these bronze bushings run the machine in feed mode and add a few drops of oil just inside the shaft collar that hold the shaft in place. Also add a few drops to the inside of the machine so both sides of the bushing gets oil. It is recommended to occasionally oil the sealed roller bearings under heavy use.

**STRIKE DIE:** The groove in the lower die should be cleaned periodically using a toothbrush to remove any dirt or build up.

**SENSOR EYE:** Clean the lower reflector tape located on the base plate of the machine. Dust will cause the beam to not reflect correctly. Clean when necessary.

**REMOVEABLE SCREWS:** When these show signs of wear or stripping, replace as soon as possible. If these strip or hollow out they can be costly to remove. If you do keep your FC114ASP clean and in top condition, it will give you years of service.

# COMPONENT IDENTIFICATION

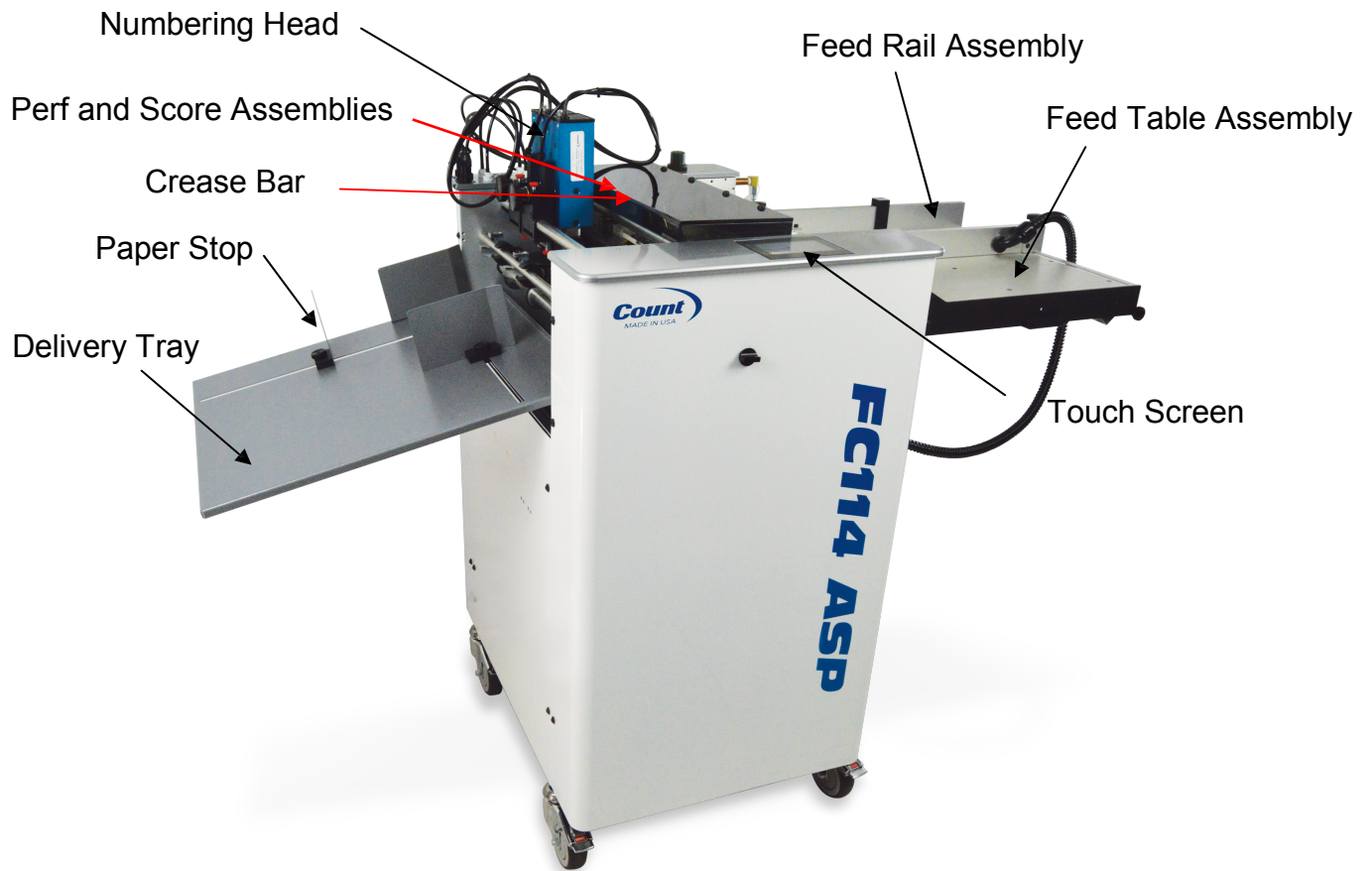

## REFERENCES

Touch Screen	Pg. 4
Feed Table Assembly	Pg. 15
Delivery Tray	Pg. 15
Numbering Head	Pg. 19
Perf and Score Assemblies	Pg. 25
Crease Bar	Pg. 27

## **SETTING UP YOUR FC114ASP OUT OF THE BOX**

1. Open top of crate and remove machine, one large box, and two small boxes.
2. The large box will contain your delivery tray, and padded envelope containing one ruler, 4 T-wrenches, Operators Manual, Air Feed Rubber Caliper, 3 glass balls, 3 plastic balls, Power Cord, and any other accessories you may have ordered with the machine.
3. One small box is empty the other small box will contain the numbering heads and ink cartridges, and wheel pick.
5. Place delivery tray in front so tray hooks under the top steel dowels located directly below the exit shaft. They will rest on the lower dowels and hang in place.
6. Install the numbering heads onto the black brackets and tighten the numbering heads. See pg. 19.
7. Install the tools into the tool holder located at the bottom of the feed table.
8. Install the power cord to the outlet located on the lower right side of the operator side cover.
9. Check the voltage on the outlet of the machine and plug in your machine to the correct voltage outlet. Do not plug in to the incorrect voltage or damage to the machine will occur. If you are not sure the voltage please contact Count Machinery.

# FC114ASP

## TOUCH SCREEN CONTROLLER

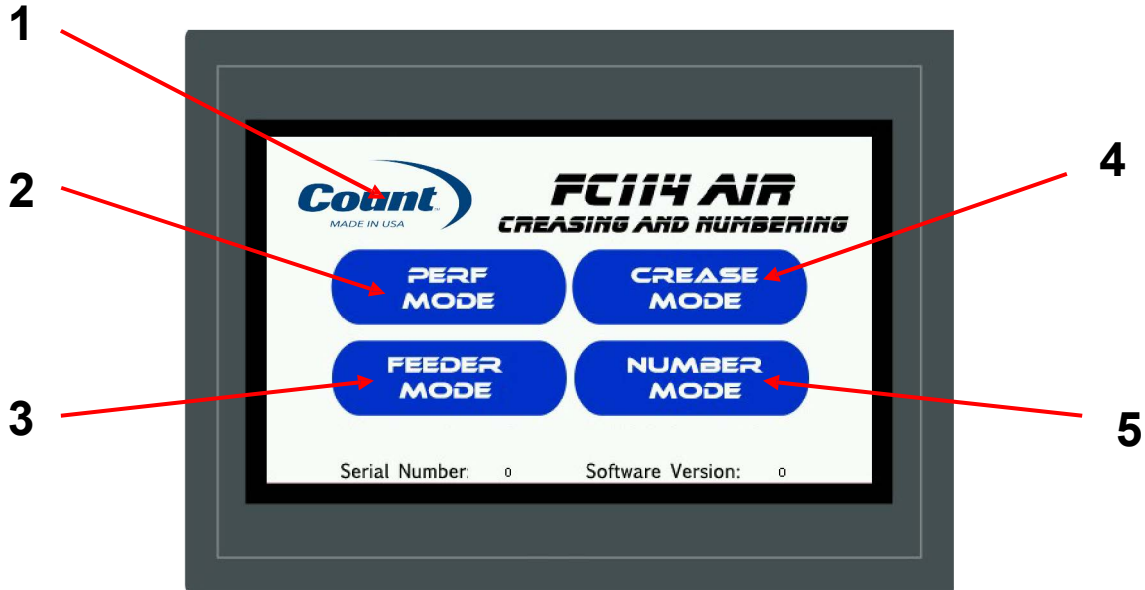

### THE TOUCH SCREEN CONSISTS OF FOUR SECTIONS:

1. Count Logo and Service Access
2. Perf Mode
3. Feeder Mode
4. Crease Mode
5. Number Mode

### Touch Screen Operation

When the machine is turned on the display may take up to 7 seconds for the home screen to display. There is a screen saver that will turn the display off if the machine is not touched within 30 minutes. The power light will stay illuminated letting you know the machine is still on.

### Count logo and Service Access

If the logo is pressed a password screen is displayed. This is for factory and service access only. This screen is for internal use only. The password is not given out.

## Perf Mode

From the home screen press the perf mode button the perf mode screen will be displayed.

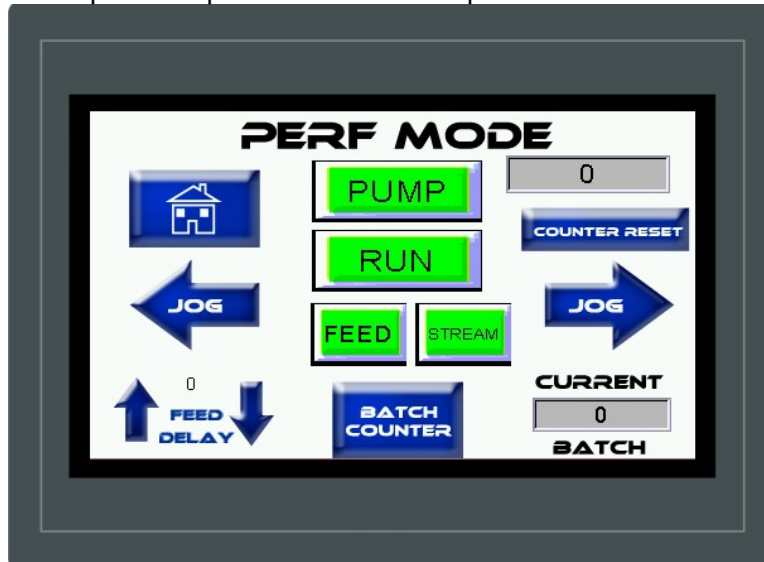

Home: Takes you back to the home screen.

Counter Reset: Resets the displayed counter to 0.

Jog Left and Right: Slowly advances the rollers left or right.

Batch Counter: Allows for stopping the machine after a batch number is reached.

Pump: Turns the pump on.

Run: Turns on the transport.

Feed: Starts the pulse feeding of paper

Stream: Turns of the pulse feeding and starts the stream feeding of paper.

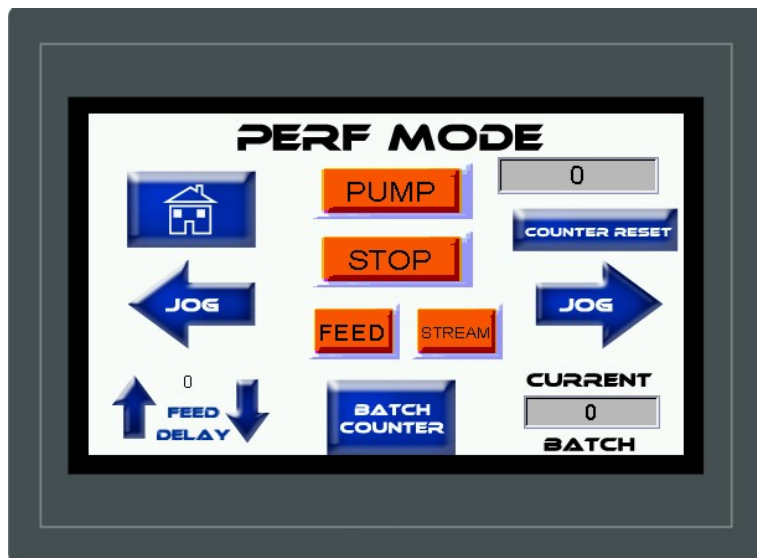

When the Pump, Run, Feed, and Stream Buttons are pressed the Graphic will change red and the stop button will flash. This is the indicator the machine is running.



## Feeder Mode

Feed mode is the mode to run your FC114ASP as a feeder into our CountCoat UV Coater. It runs much slower than the other modes giving the sheets enough spacing to move through the UV coater.

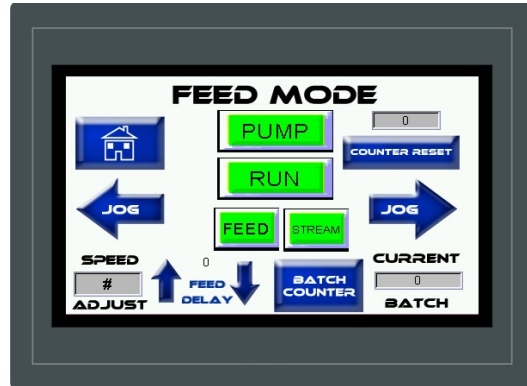

Home: Takes you back to the home screen.

Counter Reset: Resets the displayed counter to 0.

Jog Left and Right: Slowly advances the rollers left or right.

Batch Counter: Allows for stopping the machine after a batch number is reached.

Speed Adjust: Changes the speed of the transport.

Feed Delay: Changes the delay of the next sheet, increasing the sheet spacing.

Run: Turns on the transport and starts the feeding of paper.

## Crease mode

Crease mode is used to apply a Compression Crease/Score to a piece of paper. In this mode there are several Automatic Setup selections or you can do a custom selection and enter the distance in mm.

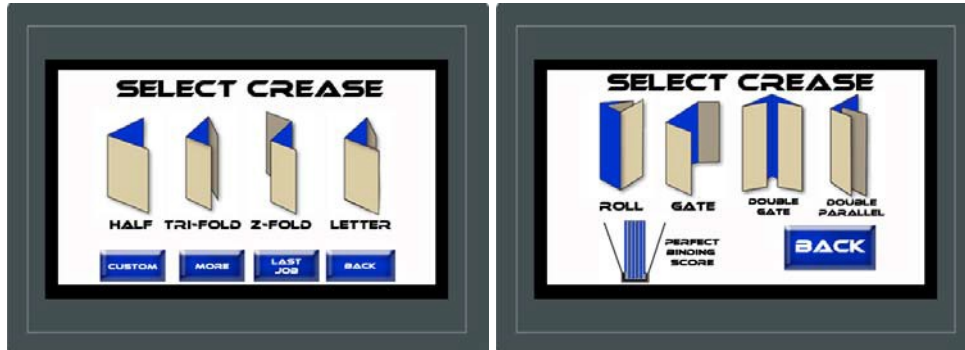

Crease selections include half, tri-fold, z fold, letter fold, roll fold, gate fold, double gate, double parallel, 3 perfect bind selections and 12 custom crease locations.

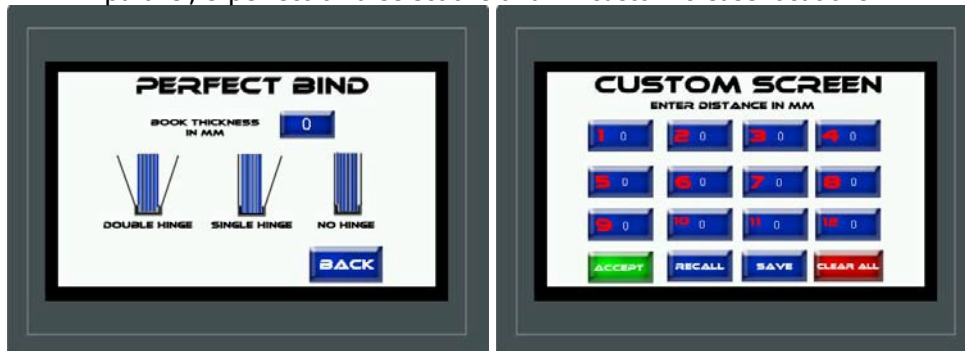

## Number Mode

Number mode is used to apply a numbering impression to a piece of paper. In this mode enter the positions and what number head you would like to use for that position.

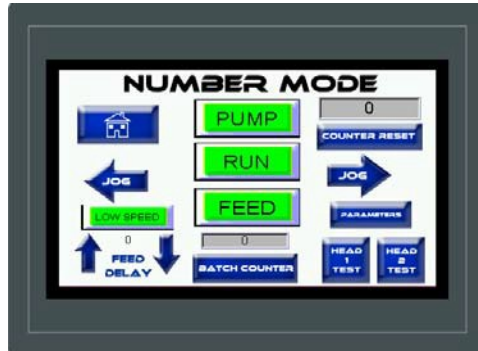

## PROGRAMMING FOR NUMBER MODE

In Numbering Mode it is important to understand how to program the positions. The machine must be programmed in order from the lead edge of the sheet. Each Position can fire Head 1, Head 2, or Both. **If there are numbers in the positions already you must hit clear all and redo the programming.**

Press the Number Mode Button > Positions > Clear All > 1 Position > Enter in Position > Select Head 1, 2, or Both > Accept > Pump > Run > Feed.

### EXAMPLE:

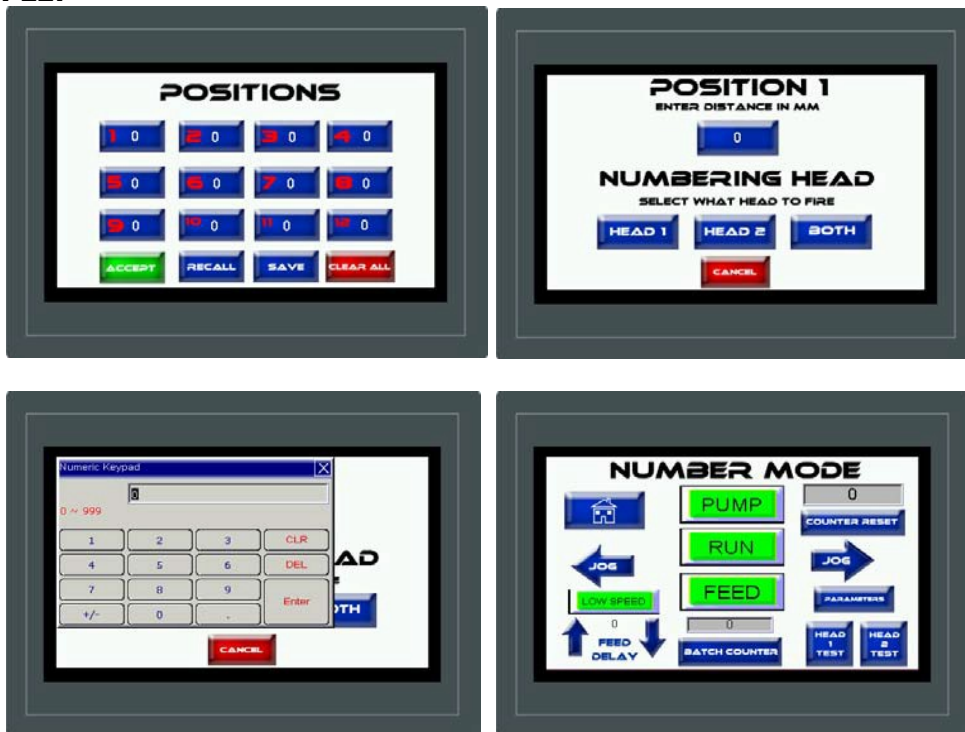

# TRANSPORT OPERATION



- The Run Button will start the Transport in any given mode. Press it again to stop the transport. Each Mode has a timeout feature to preserve the life of the machine.
- A document may be slowly advanced through the transport by pushing and holding one of these buttons.





The motor should advance transport at slow speed and stop whenever finger is lifted.

- Controls on-off function of motor.



Machine will run at mode and speed previously selected.

- Machine will stop.  

# PROGRAMMING FOR CREASE MODE

**Half Fold:** Press the Crease Mode Button > Half > Start Measuring > Physically Run a sheet through the machine for the sensor to measure > Accept > Pump > Run > Feed.



**Tri-Fold:** Press the Crease Mode Button > Tri-Fold > Start Measuring > Physically Run a sheet through the machine for the sensor to measure > Accept > Pump > Run > Feed.



**Z Fold:** Press the Crease Mode Button > Z Fold > Start Measuring > Physically Run a sheet through the machine for the sensor to measure > Accept > Pump > Run > Feed.



**Letter Fold:** Press the Crease Mode Button > Letter > Start Measuring > Physically Run a sheet through the machine for the sensor to measure > Accept > Pump > Run > Feed.



**Roll Fold:** Press the Crease Mode Button > More > Roll > Start Measuring > Physically Run a sheet through the machine for the sensor to measure > Accept > Pump > Run > Feed.



**Gate Fold:** Press the Crease Mode Button > More > Gate > Start Measuring > Physically Run a sheet through the machine for the sensor to measure > Accept > Pump > Run > Feed.



**Double Gate Fold:** Press the Crease Mode Button > More > Double Gate > Start Measuring > Physically Run a sheet through the machine for the sensor to measure > Accept > Pump > Run > Feed.



**Double Parallel Fold:** Press the Crease Mode Button > More > Double Parallel > Start Measuring > Physically Run a sheet through the machine for the sensor to measure > Accept > Pump > Run > Feed.



**Perfect Bind Double Hinge:** Press the Crease Mode Button > More > Perfect Binding Score > Enter The Book Thickness > Double Hinge > Start Measuring > Physically Run a sheet through the machine for the sensor to measure > Accept > Pump > Run > Feed.

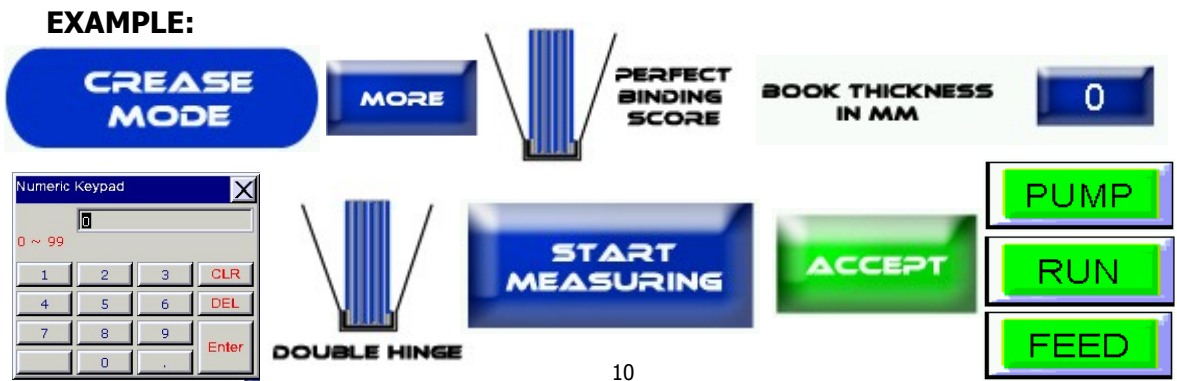

**Perfect Bind Single Hinge:** Press the Crease Mode Button > More > Perfect Binding Score > Enter The Book Thickness > Single Hinge > Start Measuring > Physically Run a sheet through the machine for the sensor to measure > Accept > Pump > Run > Feed.

**EXAMPLE:**

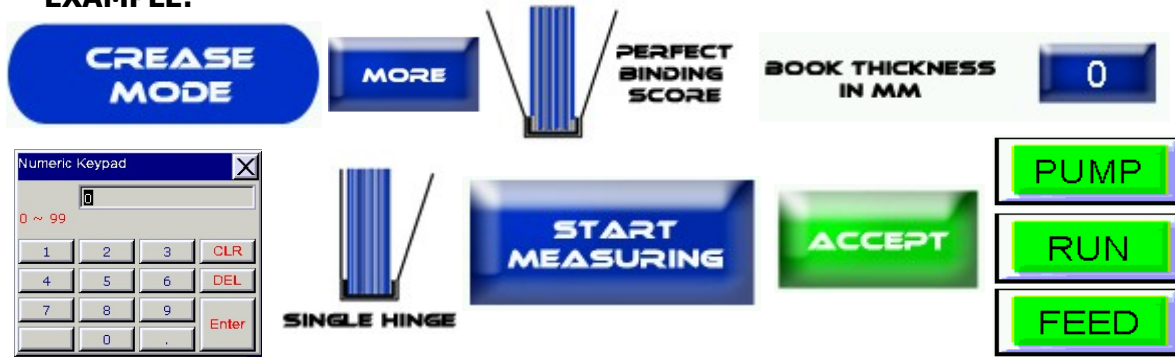

**Perfect Bind No Hinge:** Press the Crease Mode Button > More > Perfect Binding Score > Enter The Book Thickness > No Hinge > Start Measuring > Physically Run a sheet through the machine for the sensor to measure > Accept > Pump > Run > Feed.

**EXAMPLE:**

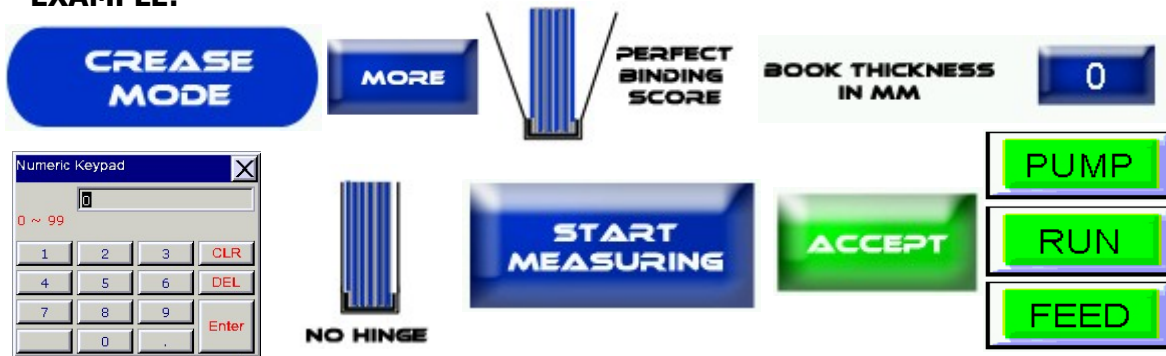

**Custom Crease Job:** Press the Crease Mode Button > Custom > Enter In Distance For each Crease in mm > Accept > Pump > Run > Feed.

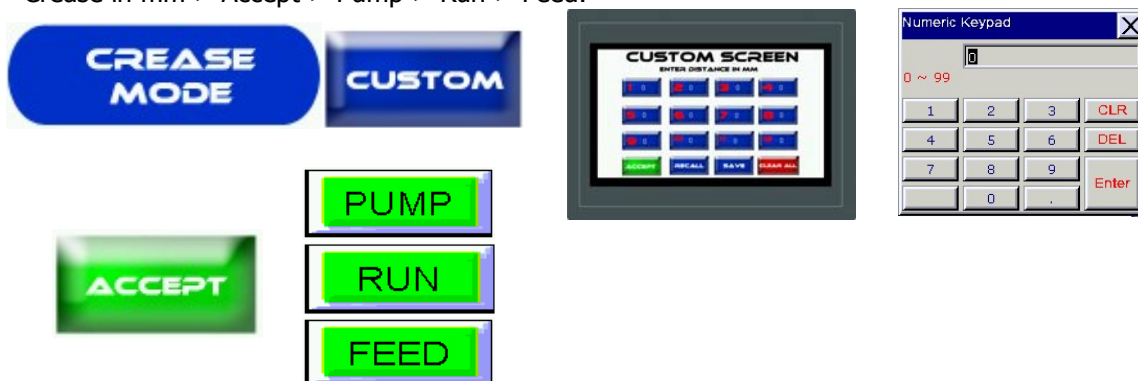

**Saving Custom Crease Jobs:** Press the Crease Mode Button > Custom > Enter In Distance For each Crease in mm > Save > Select Position to save in 1, 2, 3, or 4.



**Recalling Custom Crease Jobs:** Press the Crease Mode Button > Custom > Recall > Accept > Pump > Run > Feed.

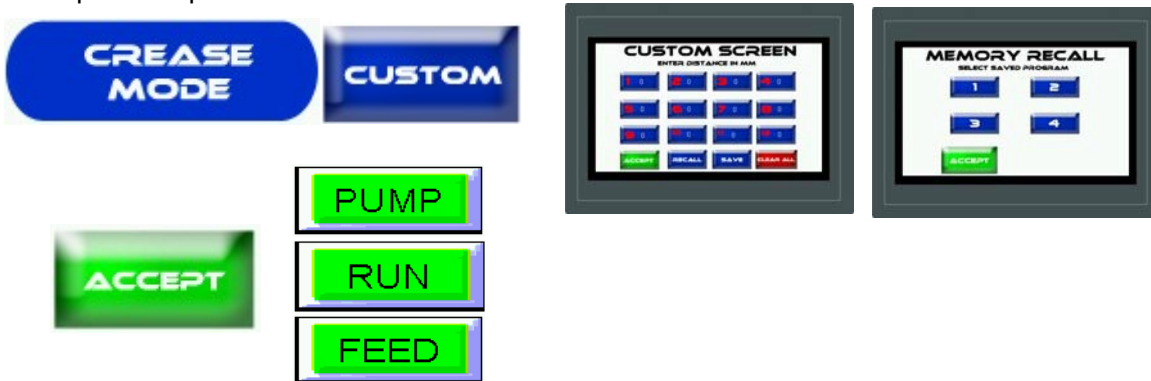

**Micro Adjusting the Crease Position:** Press the adjust button from the run screen. You can micro adjust each crease by pressing the arrow keys each direction. Each press will adjust by 1/13th of a mm. Each Adjustment is relative to the one before it so if you adjust crease 1 by 3 clicks it will also move all the creases after it. You would then need to adjust them back 3 clicks each.

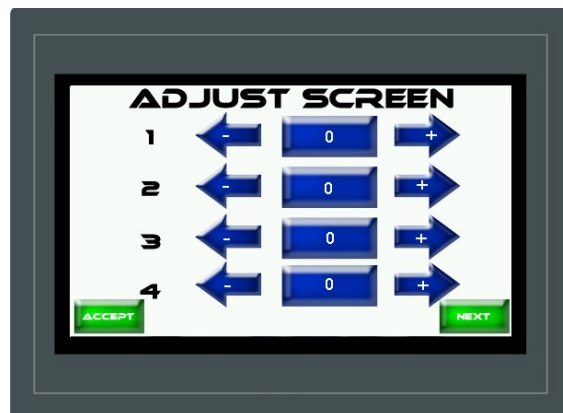

**Batch Counter:** Press the Batch Counter button from the run screen in any mode and it will take you to the Batch Count Screen.



Press the Enter Batch Amount Button to enter in the number you want to run per batch.

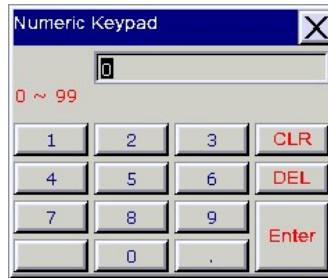

Press the Reset Batch Button to start from 0. Press the On Button. The button turns red as shown below.



As you are running and the batch number is reached the screen will display " Batch Complete.





# TOOL HOLDER ASSEMBLY

## INSTALLING THE TOOS INTO THE HOLDER

The delivery tray is made to fit 2 different configurations depending on if the machine is on a dedicated stand or if the machine is on a table. Position the tray to slide it under the 2 dowel pins and rest the angle stop up.



Register Ball Rack

## FEED TABLE ASSEMBLY (top)

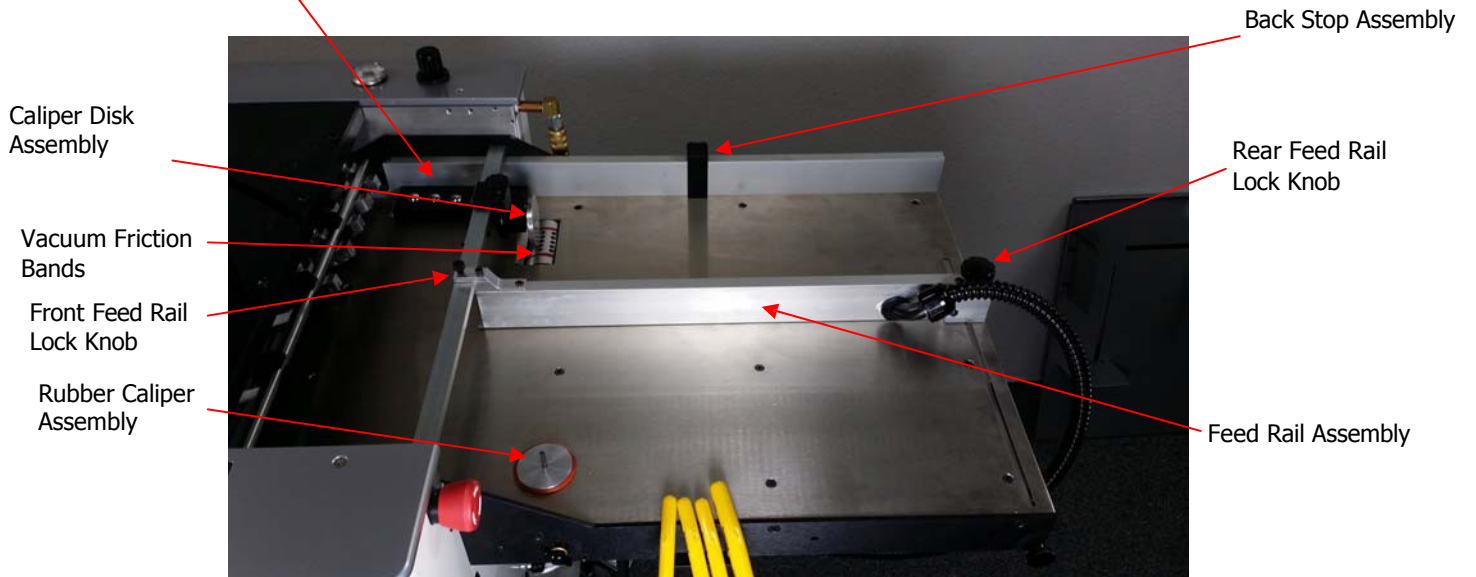

Vacuum Drum O-Rings

## FEED TABLE ASSEMBLY (bottom)

Drive Belts

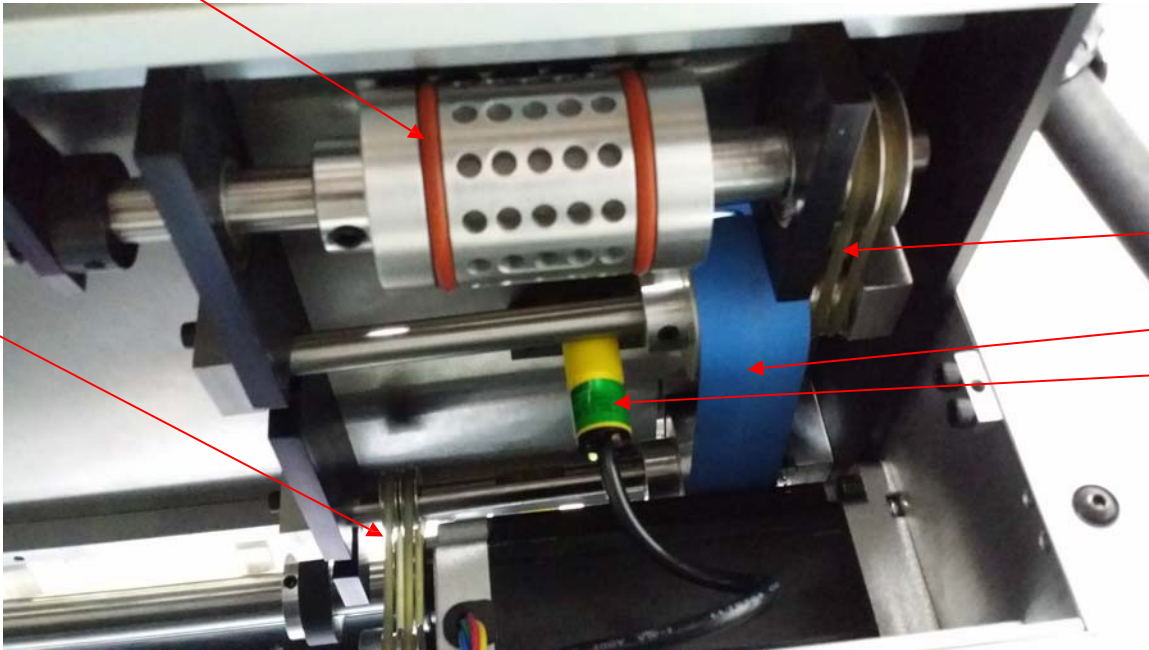

Drive Belts

Registration Belt

Sensor

Rubber friction band  
Rubber drive belts

Reg Belt

Sensor

Replacement rubber for vacuum wheel  
Drive from the motor to the reg table and  
also from the belt hub to the vacuum drive  
Blue belt on angle to drive paper into the  
fixed register rail  
Pulse sensor controls the pulse feeding of  
paper in a controlled manor

## ADJUSTING THE FEED RAILS

If you are experiencing skewing of the sheets while running please see "Adjusting for paper skew" on page 27.

The fixed feed rail on your FC114ASP is factory set and should not be adjusted. If absolutely necessary it is possible to have slight adjustment to the rail by using the button head screws on the bottom of the feed rail. By making this adjustment the machine may no longer function as desired. Please use caution and speak to a trained Count service technician before making any adjustments to the fixed feed rail. If done improperly this may void your warranty on the machine.

## LOADING THE FEEDER

Take one sheet of the stock you are going to run. Please it against the fixed feed rail and the caliper disk.



Loosen the lock knob on the back stop assembly and move it to the end of the sheet. **DO NOT PINCH THE SHEET!** This is to prevent the sheets from moving backward not to push the sheets forward. Loosen the front and rear lock knob on the operator side feed rail and adjust it up to the side of the paper. **DO NOT PINCH THE SHEET!** This is supposed to be aligned to the side of the sheet but not to pinch. Proper alignment of the rail is imperative to getting consistent feeding of stock.



## SETTING THE AUTOMATIC FEEDER

For efficient Auto-feeding, the setting of the Paper Caliper is very important. Make sure the pump is off while adjusting the caliper. Use a piece of the stock to be run as a "feeler gauge". Place one sheet under the caliper and place another sheet on top of that sheet. Now move it back and forth under the caliper while adjusting the caliper down (counterclockwise to lower, clockwise to raise) until the second sheet is not able to go under the caliper.

### Caliper disk Vs. Rubber caliper

For most jobs you will use the caliper disk. If you are struggling with feeding on light stocks or carbonless forms you may want to switch to the rubber caliper assembly. It is design to give added grip to the second sheet to prevent double sheets. As you use the rubber caliper it will create a flat spot on the rubber and will need to be rotated periodically.



### Steel vs. Plastic vs. Glass Balls

The type and combination of balls is dependent on the weight of the stock and the amount of curl on the paper. If you are experiencing skewing or the machine is not registering you may need to change the balls. The lighter the stock, the lighter the ball combo needs to be. To remove the steel balls use a magnet. To remove the plastic or glass use a piece of tape.

## CONTINUOUS FEEDING

Once your job is in progress, you can continually add paper to the feeder hopper without stopping the transport. The amount of stock that can be loaded will vary as paper weights and stocks will vary. For most stocks you will be able to load 1" to 1 1/2" of stock at a time. As you increase the amount of stock you may need to increase the pressure flow from the pump. Also when the stock mount decreases you may need to decrease the amount of pressure flow.

## FEEDING NOTES

- When set properly, the feed is very efficient and flexible. When neglected it can become very frustrating to run even the simplest job. The adjustments previously discussed are very important.
- The FC114ASP is capable of running 20lb. single sheets, 4 part forms up to 16 point. It is also very capable of handling gloss, coated, and even laminated stocks. Its flexibility is directly related to the operator's experience.
- All carbonless sets are fed into the FC114ASP with the glued edge against the fixed rail or against the adjustable rail feeding open edge through the machine.
- To clean the vacuum rubber friction bands , use only water on a clean cloth. Wipe the rubber use the jog button to rotate the vacuum wheel then wipe again. Repeat until both are wiped down completely.
- As you increase the amount of stock you may need to increase the pressure flow from the pump. Also when the stock mount decreases you may need to decrease the amount of pressure flow.
- The lighter the stock, the lighter the ball combo needs to be.

# NUMBERING HEAD

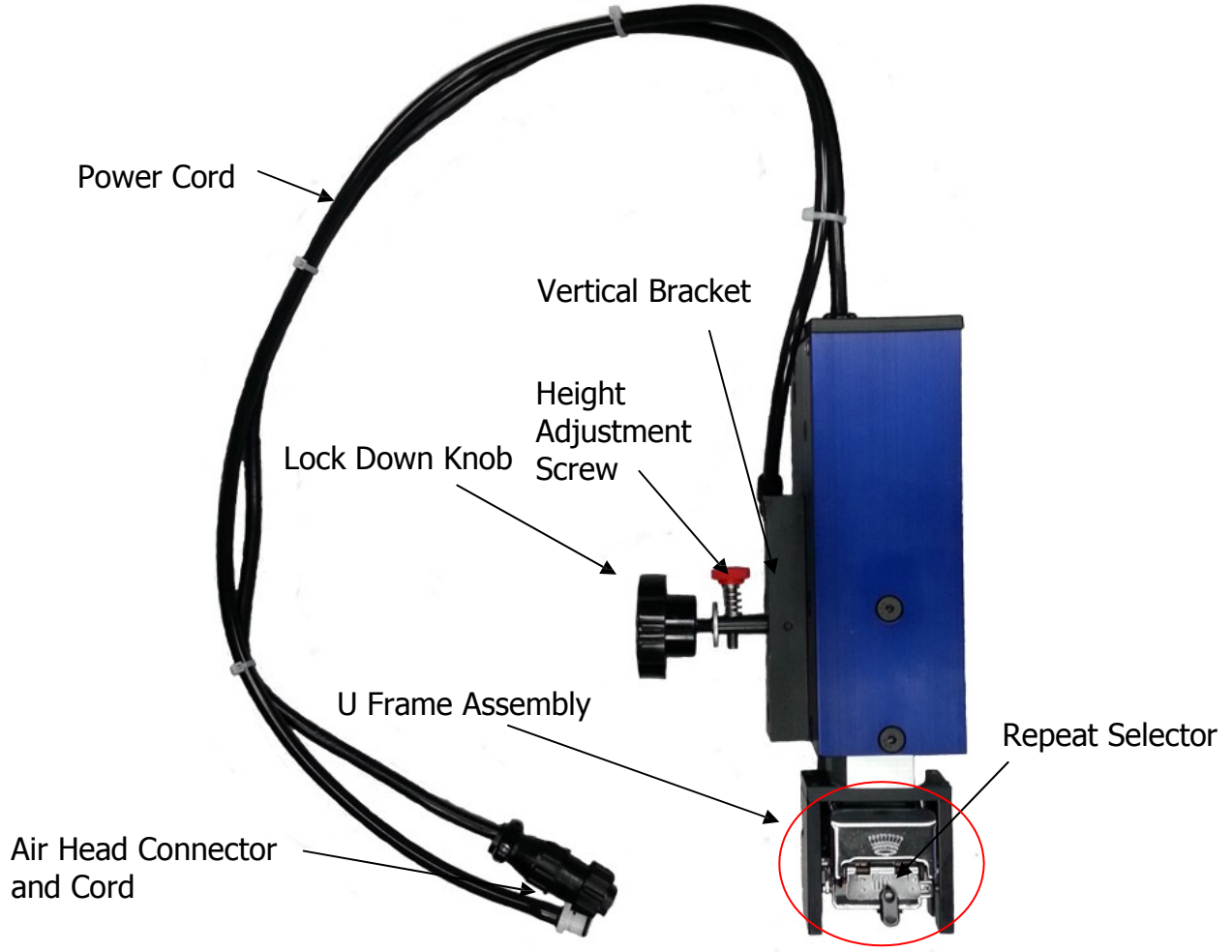

- Numbering Head -** The Numbering Heads can be operated simultaneously and the wheelset can be rotated by hand in any direction.
- Vertical Head Bracket -** Mounts to the side of the Numbering Head and positions the head into the head of the Mounting Bracket.
- Pressure / Height Adjustment Screw -** This screws into the Vertical Head Bracket Stem to adjust the pressure of the strike of the head.
- Pressure / Height Adjust. Screw Spring -** This spring is necessary to retain the setting of the screw.
- Head Lock-Down Knob -** Tightens the Head Assembly to the Mounting Bracket.
- Lock-Down Knob Washer -** Installs with the Lock-Down Knob. (Unidirectional)

**Wheel Assembly**

**Ink Swing Arm**

**Repeat Selector C Clip**

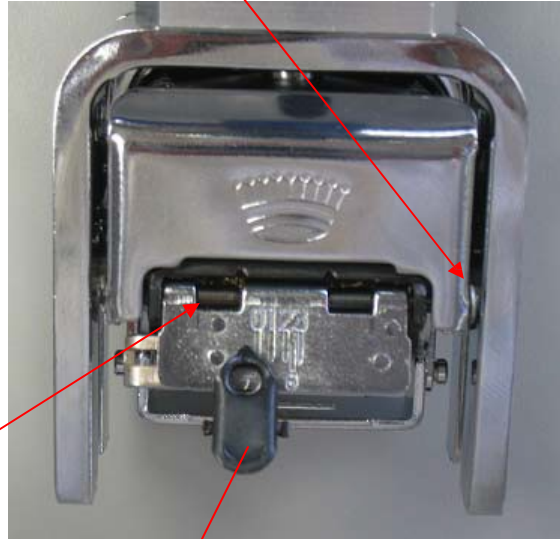

**Repeat Selector Shaft**

**Repeat Selector**

**Numbering Head Part Number: W-ASRCM0100**

## DEPRESSING A WHEEL

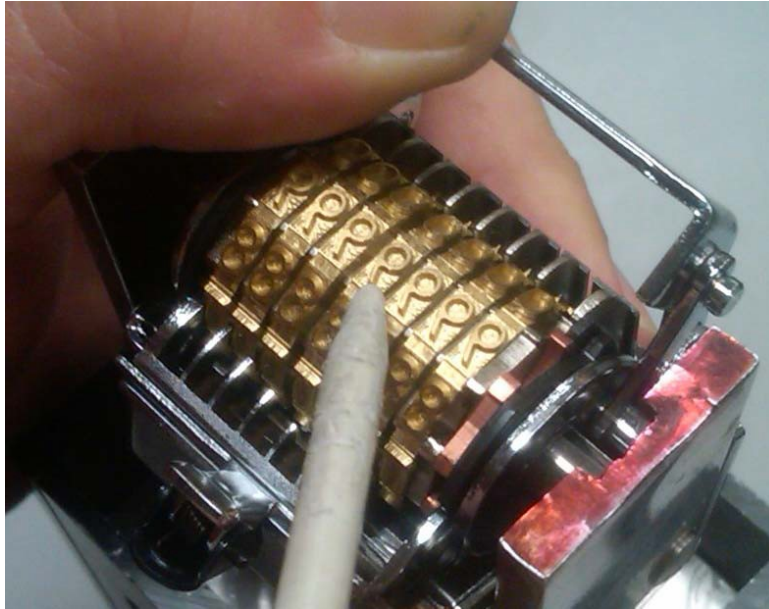

The standard Electric Numbering Head is capable of recessing the first four (4) wheels so there is no image when striking. For example, to print the number 4750 instead of 0004750, you will need to depress the first three wheels. To do so, remove the Numbering Head from the Head Bracket and hold it upside down resting it on a flat surface. By doing this you will activate the Test Print button. This will keep the head in the "Open or Down" position for as long as the button is depressed. This will swing the Ink Cartridge away from the wheels or you can remove it altogether. Using the provided set-up tool rotate the 1st wheel until the 9 is in the up position. Then press forward slightly and down, you will feel the wheel depress below the level of the others. Do the same to the 2nd and 3rd wheel. Now you can print a 4 digit number. To return to position, simply rotate the wheel and it will pop up.

## CHANGING DIRECTION OF THE HEAD

Changing the direction of the number is done very simply by firmly twisting the U-Frame and rotating the numbering wheels in either direction. This U-frame is held in place by an O-ring that when set will firmly hold the numbering head in the set position. The ideal way to change direction of the numbers is to twist the U-frame slightly past where you want the number to settle and then back a little to your ideal position. This will allow for the rubber O-ring tension to be released as after turning the U-frame the O- ring will settle back a little from where you set it.



## ADJUSTING THE VERTICAL BRACKET

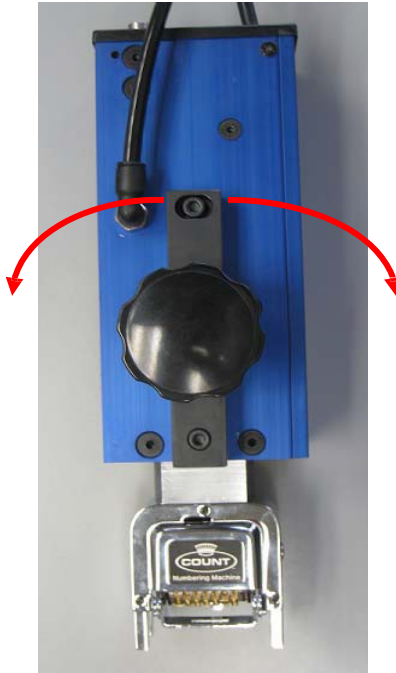

12345 12345 12345

The top of the vertical bracket is slotted to allow for movement. The effect of this movement depends on the orientation of the head. To make an adjustment to the vertical bracket, simply loosen the top screw and slide toward the direction desired, then retighten the screw. It is not necessary to loosen the bottom screw. This will allow you to compensate for a number that is heavier on one side and lighter on the other.

## ADJUSTING FOR A LEVEL IMPRESSION

To begin the leveling process, move your numbering head to the desired lateral position on the bar. To do this you must first loosen the two cap screws on the mounting bracket. Then loosen the head lock down knob on the head to allow head to slide into the mounting bracket. When these are both released, the head and bracket will slide along the bar. By using your horizontal adjust screw (Red knob on the bottom side of the mounting bracket) you can adjust the angle of the number. Clockwise rotation will tilt the numbering head higher on the feed side. Turning Counterclockwise will tilt the numbering head higher on the exit side of the machine.

Your vertical adjust pressure / adjust screw (Red Knob on the head) will adjust the height of the numbering head from the strikeplate. Use this knob for fine adjustments to pressure as well as levelness prior to tightening lock down knob and mount bracket cap screws. You are now ready to number.

## TIPS FOR LEVELING HEAD

Leveling the numbering head is the most critical part of the set up process. If the head is not level you will get a blurred or "Ghosted" Impression. This can also occur when the head is set to hit too lightly or too heavy. Never set pressure to favor the drop wheels, for this will depreciate the life of the numbering wheels.

The easiest way to check your impression is to use a 3 part carbonless set. Program the FC114ASP to stamp in one location anywhere on the sheet. Run your test sheet through the machine and check impression for pressure as well as levelness. By level we mean a level impression. Where the impression of the 1st digit is the same pressure and impression as the 5th and 6th digit and the top of the digits is the same as the bottom you are level. We do not mean "plumb level," as using a small level will not help.

## SETTING THE REPEAT SELECTOR

This allows you to select the number of times that the head will strike without advancing to the next number.

EXAMPLE: If you need to number a job which requires the same number in two (2) positions, slide the selector to "2." The head will now strike the same number twice.

**NOTE: After selecting a repeat sequence, replace head and run a test sheet through the FC114ASP.**

You should get this:

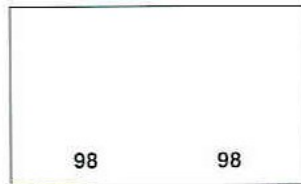
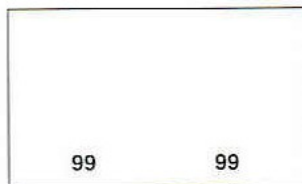
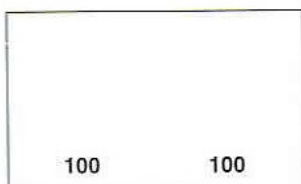

If you get this:

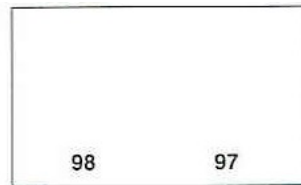
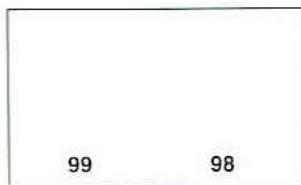
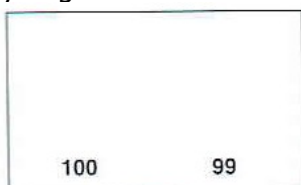

The number changes at the wrong strike, the wheel cam is not in sync with the paper. To remedy this, you must get the head to fire 1 time. Hit the silver manual firing button on top of the numbering head once. Once you have achieved a single strike the cam is now in the correct changing sequence.

## INK CARTRIDGE

The ink cartridge slides under the swing arm and locks into place. When installing a new ink cartridge, first remove the foam pad using an X-acto knife and place a small cut into the reservoir. This will supply ink to the foam through the action of the swing arm. Start with a small hole as it is easier to make the hole larger, but if you start with the hole too large you cannot control the flow of the ink.

**NOTE: The flow of ink can be sensitive to temperature. On a cold day the ink will be thicker and not flow easily, whereas on a hot day the ink will be thin and flows faster. Also, be sure to shake cartridge well.**

We also suggest that when opening a new cartridge to use the piece of tape which holds the cover on to wrap around the cartridge about 1/4 of an inch. This will help reduce excess ink on the numbering head especially when only using 3 or 4 digits where the foam would have a tendency to lift on the opposite side.

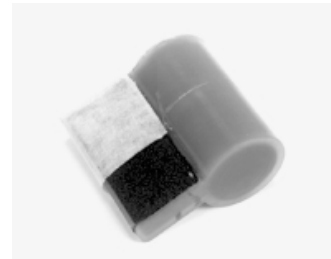
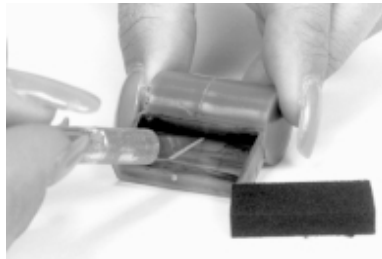
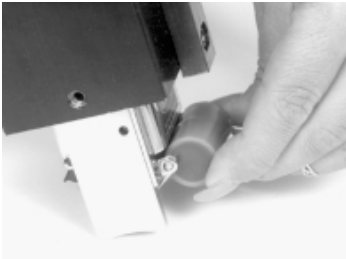

## PERFORATING AND SCORING ASSEMBLIES

To remove an old blade and attach a new blade to the pressure, adjust the mounting bracket, remove the (1) button head cap screw. **BE SURE TO TIGHTEN THE SET SCREW SECURELY TO THE BAR.** Once you have the upper and lower perf assemblies in place, you can tighten the half dog screw.



**Score Assembly Complete**  
WRASAPP0129



**Perf Assembly Complete  
with 9-1 Perf Blade**  
WRASAPP0139

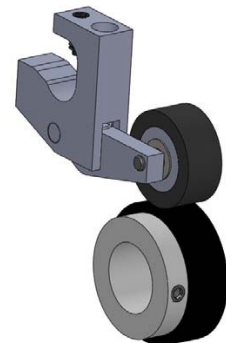

**Roller Wheel  
Assembly Complete**  
WRASAAM0933

## **GRIPPER WHEEL PERF MOUNTING**

### **Adjusting for Paper Skew**



Position your roller wheels as desired across the sheet. The more grip rollers the better the paper will register. It is recommended to use all 4 grip rollers across the sheet spaced evenly to achieve the best results.

If you are experiencing any skewing when perforating or creasing you may need to adjust the pressure adjustment screws on the outside rollers to compensate. Look at the pictures above and you will notice there are 2 rollers on the outside that have screws and lock nuts. These 2 assemblies must remain on the outside edges of the sheets. It is imperative to the function of this machine to have them on the outside.

## **FOLDING DIRECTION OF PAPER**

There is a correct way to fold a creased paper. The diagram below shows the correct direction the paper should be folded.

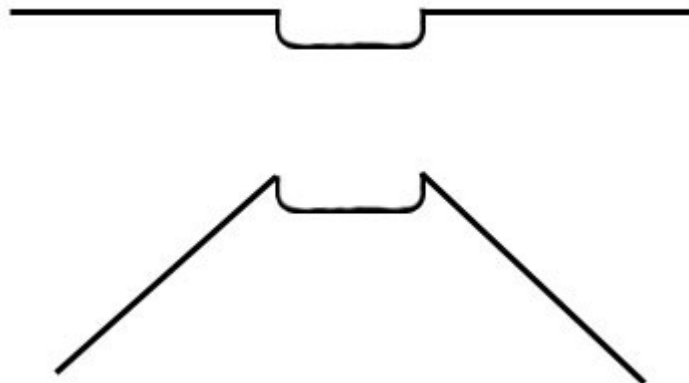

## ADJUSTING THE RAC ROLLERS

The RAC rollers are set from the factory and it is **NOT** recommended to make any adjustments to this without consulting with Count's tech-support department. Should an adjustment be necessary, please follow the steps below. Loosen the small bearing block lock screws. This allows very slight adjustments of the bearing block to be made by loosening the thumb lock and turning the height adjustment screw in the middle of the bearing block. This is a very fine thread and is capable of making very slight adjustments. Turning the adjustment screw clockwise will increase the bar pressure, as counterclockwise will decrease the pressure. Once the adjustment to the bar has been made, slightly tighten the thumb lock and re set the block set-screws.

## ADJUSTING RAC TOP DEAD CENTER

The top dead center of the RAC will need to be adjusted from time to time. To do this turn the machine off, remove the operator side cover, and manually rotate the eccentric shaft to the top dead center. Then locate the adjusting shaft collar on the end of the eccentric on the operators side and take a 5/32 allen wrench and loosen the button head screw and rotate it to the 6 o'clock position. This will ensure proper alignment of the crease bar.

## CHANGING THE LOWER CREASE DIE

The lower crease die can easily be changed to accommodate thicker stocks by removing the lower bar as shown below. Slide the bar out and flip it over to use the wider die channel. Do not force the die into the machine. If the die binds, remove the die and reinsert. If it continues to bind, check for obstructions. The die should slide in very effortlessly.



## CHECKING THE SENSORS

The FC114ASP has 3 sensors that are needed for normal operation;

1. Pulse feed sensor (located under the feed table)
2. Crease Paper Sensor (located directly in front of the crease bar)
3. Numbering Sensor (located directly in front of the numbering heads)

1. Turn machine power on and allow screen to turn on
2. There should be 2 lights on each of the sensors a green indicating power is getting to the sensor and orange that is the reflecting signal. If both light are not on there is a problem and must be fixed before you are able to run.
3. Make sure the sensor reflector tape is located on the base plate and the red beam from the sensor is hitting the tape. If not loosen the screws on the sensor and adjust the beam until it is on the tape.
4. If all above steps work correctly the sensor is working properly, if not, contact the Count Machinery Company service department.

## DRIVE CHAIN TENSION

The chain that drives the upper crease die in time will stretch. This is a common occurrence in chains. The spring tensioner bracket will automatically adjust the tension. It is important that this chain remain taught and free of any play. It is recommended to check this periodically. If there is play in the chain drive, make sure the adjustment spring is in the correct location.



## REMOVING THE PERF SHAFT



Open the plastic cover and locate the perf shaft. Loosen the 2 set screws on the hub next to the operator side frame. Remove the non operator side cover. Loosen the 4 screws shown below on the belt tensioner pulleys. Remove the belts. Do not loosen or remove any pulleys from the shafts for any reason. Slide the perf shaft out the pulley side. It is only necessary to slide the shaft out about 6 to 8 inches.

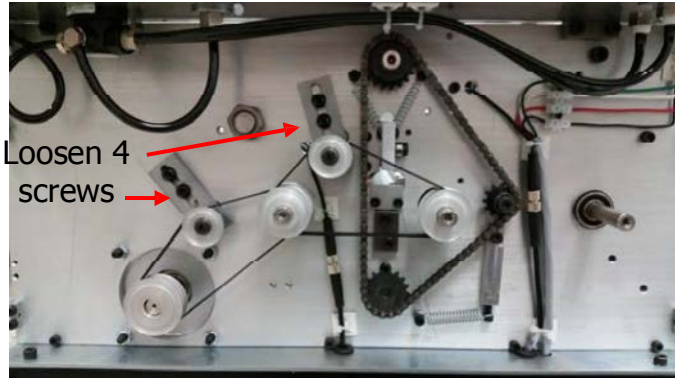

With the shaft slid to the side, you can access the lower hubs and reconfigure them as needed to complete any job. After you have configured the lower shaft, replace the shaft into its bearing and secure the set screws. The shaft should not be able to move side to side. With both drive belts in Position, re-tension the belt idlers and tighten while applying constant firm pressure on the belts. Replace covers. Align upper assemblies accordingly.

# TROUBLE SHOOTING

- **POWER DOES NOT TURN ON**
  1. Check circuit breaker under operator cover.
  2. Check outlet for power.
- **POWER TURNS ON BUT HMI DOES NOT LIGHT UP**
  1. Check 5 amp breaker under the operator cover.
  2. Make sure the green lights on the power supply light up. If not Check outlet power.
  3. Check wiring to the plc and hmi.
- **TRANSPORT "LOCKS UP" AFTER CREASING**
  1. Make sure you are using the correct side of the lower crease bar .01 and thicker should use the wide crease groove.
  2. Check the switch on the operator side frame to see if the stop screw is hitting it.
  3. Check the relay to see if it is sticking. Tap the side to release if stuck.
  4. Turn power off and check to see that the transport turns freely (oil when necessary).
  5. Possible damage to plc.
- **FEED TABLE NOT FEEDING CORRECTLY**
  1. Check caliper setting.
  2. Feed wheels do not have equal pressure on them, check adjustment.
  3. Check and adjust the pressure and vacuum on the back panel.
- **SHEETS NOT FEEDING STRAIGHT**
  1. Unequal feed wheel pressure.
  2. Align feed rails "check for squareness". This can be checked by the lead edge of the paper feeding into the machine should line up with the front edge of the feed plate.
  3. Not enough pressure on forwarding rollers.
  4. Clean ALL rubber rollers with water.
- **PERF IS NOT STRAIGHT**
  1. Check for equal pressure on all grip wheels and that none are hanging up.
  2. Use adjustment screws on the outside rollers to add pressure. This will help to straighten the perf out.
  3. Recheck all steps under (SHEET NOT FEEDING STRAIGHT)
- **PERFORATION IS NOT CLEAN OR CUTS SHEETS**
  1. Not enough pressure on perf wheel.
  2. Perf blade is worn.
- **CREASE NOT REGISTERING ON SHEET**
  1. Make sure you are using the correct side of the lower crease bar .01 and thicker should use the wide crease groove.
  2. Clean all Rubber Rollers
  3. Make sure to use a minimum of 4 entry and 2 exit gripper wheels on every setup.
  4. Check all pulleys to make sure they are securely tensioned on shafts.
  5. Check to see that machine transport turns freely.
- **CREASE APPEARS WEAK**
  1. Crease bar not level.
  2. Not enough pressure, adjust RAC rollers with height adjustment screw.
  3. Too much pressure, motor cannot make full stroke.
  4. Crease bar not tightened properly on bracket.
- **CREASE BAR DOES NOT ROTATE**
  1. Crease bar set too low, cannot make full stroke.
  2. Crease bar is dirty. Clean with damp cloth and wipe clean.
  3. Verify red light on creaser plc at Y4 is firing on and off.



- **NUMBERS NOT REGISTERING ON SHEET:**
  1. Clean all rubber rollers.
  2. Check pressure on grip wheels. If these are not down firmly your registration will be off.
  3. Check all pulleys to make sure are securely tightened to shafts.
  4. Check to see that machine transport turns freely.
  
- **NUMBER APPEARS BLURRY:**
  1. Head is not level. See "leveling a head" page 22.
  2. Not enough pressure, adjust with height adjustment screw.
  3. Too much pressure, cylinder cannot make full stroke.
  4. Head not tightened properly to head bracket.
  5. Ink cartridge is empty or flow of ink is not consistent (**TRY ROTATING THE INK PAD**)
  
- **HEAD FIRES BUT NUMBER DOES NOT ADVANCE:**
  1. Head set too low cannot make full stroke
  2. Possible damage or broken action indicator.
  3. May need to send to headquarters for service.
  
- **NUMBERS TURN OUT OF SEQUENCE:**
  1. Head is dirty. Clean with Simple Green then oil with 3-1 oil.
  2. Head is worn or damaged, contact COUNT service department.
  
- **NUMBERS REPEATING DOWN SHEET:**
  1. Exit roller is located directly behind the numbering head and the ink is getting on the roller. Move roller left or right so it is not behind the numbering head.

# STRIKE PERF ASSEMBLY SETUP AND USE

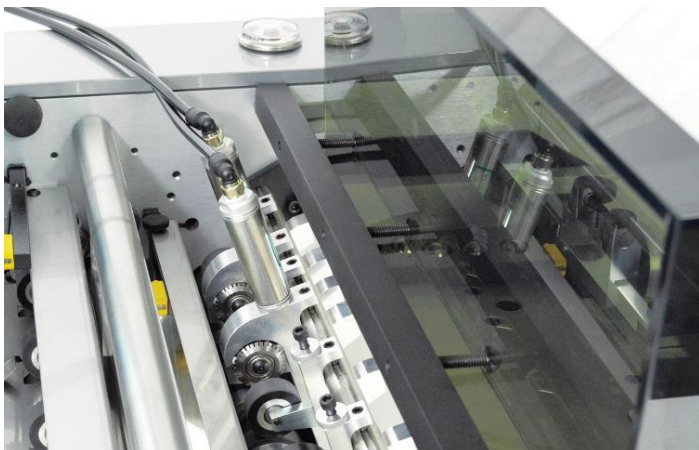

## Machine Setup

Ensure that the air pressure line is connected to the machine. Check the indicator on the pressure regulator. All machines are factory set at 40 psi, however the pressure can be adjusted if needed. Note that if the pressure is adjusted too high, premature wear is likely to occur on the perf blade, and if the pressure is too low, the perf section will not separate evenly. Check that the strike perf air hose is plugged into the machine. Indicators “1” & “2” are located next to the ports to distinguish the strike perf assemblies. Before turning on the machine, check to ensure that the perf blade is approximately centered over W-ASAPP0133 (LOWER AUTO PRESSURE PERF HUB).

## Menu Setup



Fig. 1

From figure 1, select the window that shows “STRIKE PERF MODE”. This will lead to perf function screen shown in figure 2. The perf function screen sets the locations of the two strike perf assemblies. The buttons next to the “select perf” line allows the operator to turn on either or both perf assemblies. The perf assemblies, 1 & 2, cannot be set to strike at independent locations. By default when a perf assembly

is set to the “on” function, the perf blade will be down as the paper passes through the machine. The button next to the number 1, to the right of “Distance from lead edge to up position” on this screen allows the user to set when the perf blade moves into the upward position, disengaging the perf along the paper path. The minimum distance from the leading edge of the paper that the blade can be moved to the upward position is 55mm or 2.2 inches. The buttons to the right of numbers 2 and 3 determine the distance that the blade will move back to a perforating position. If an operator only wants to perf the lead edge of the paper, the boxes for 2 and 3 will need to be blank.

Blanking the numbers is accomplished by pressing reset in the lower right portion of the screen. Note that pressing reset will blank out the numbers for all boxes. Distances entered in boxes 1,2, & 3 are measured from the leading edge. If the numbers in boxes 2 & 3 from figure 2 are less than box 1, only the measurement for box 1 will register.

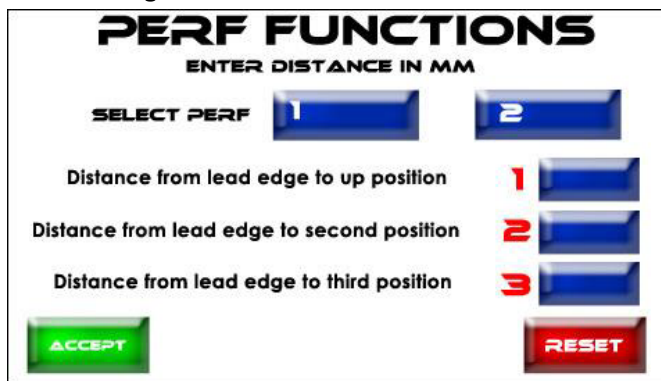

Fig. 2

If a number is entered into the screen that is less than 55mm, the error screen shown in figure 3 will appear. To go back to the “Perf Functions” screen, a number greater than 55mm must be entered into the box on the right.



Fig. 3

Once finished, select accept and the “STRIKE PERF MODE” will appear as shown in figure 4. If perf locations need to be adjusted the “PERF FUNCTIONS” screen can be accessed again by selecting the “STRIKE PERF OPTIONS” button in the lower right portion of the screen. The image below in figure 5 is a break down of relevant parts for the strike perf assembly.

NOTE: As Martin Yale continues to update COUNT™ products, the user interface on your machine may appear different than the images shown in this document.

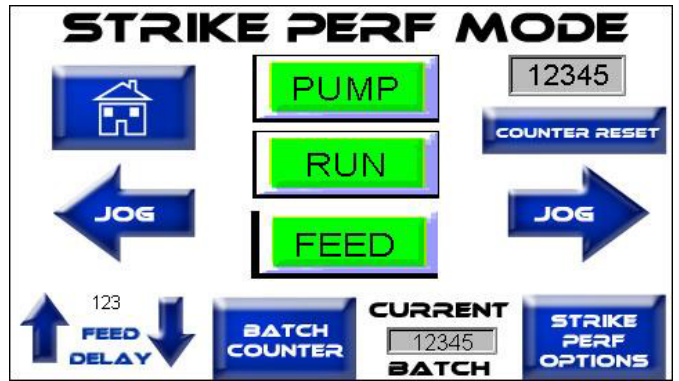

Fig. 4

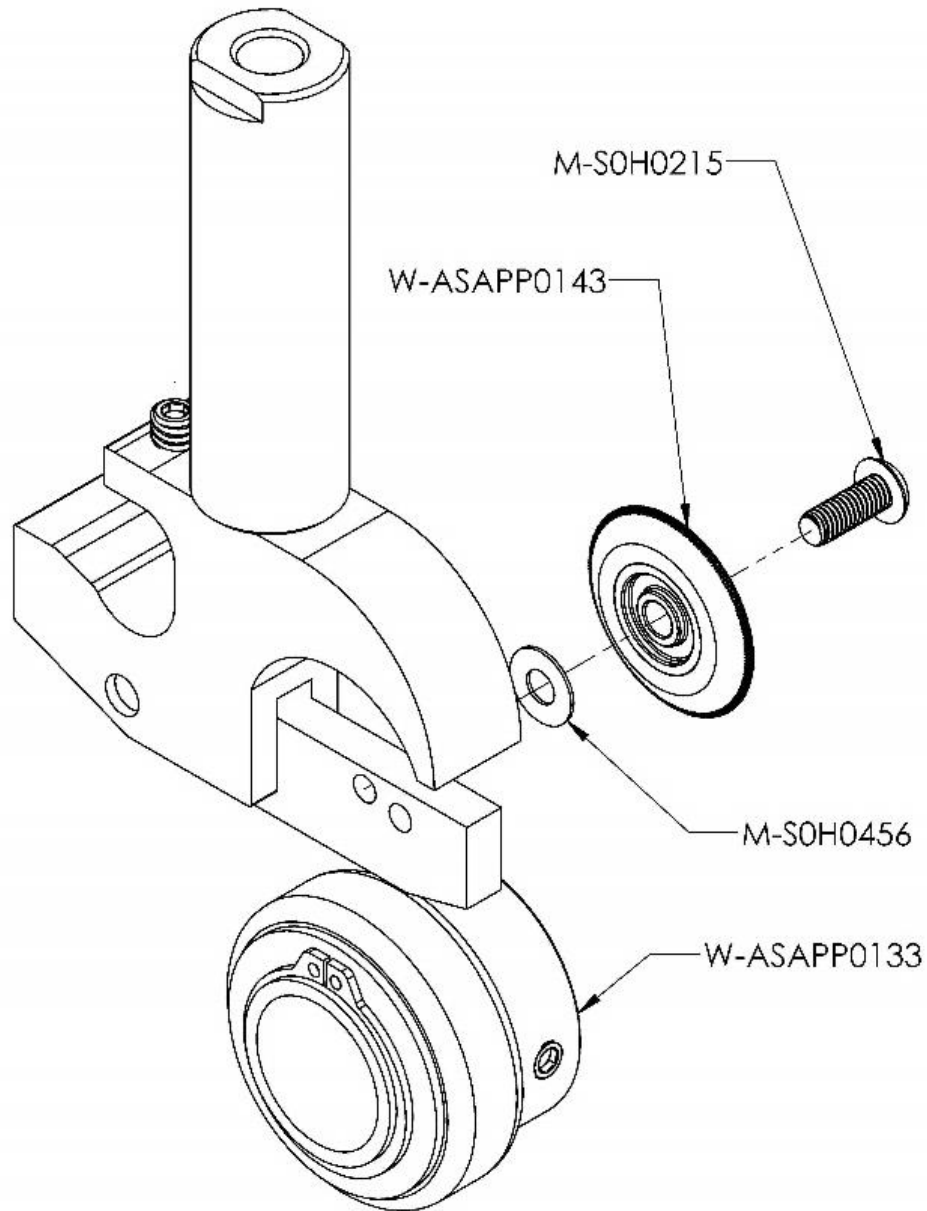

Fig. 5



**By Martin Yale Industries**

251 Wedcor Avenue, Wabash, Indiana 46992  
count-usa.com | 800-225-5644 | info@martinyale.com